

UH LINE Series

A single source with maximum flexibility

- HAM LET® "UH" Series design for ultra vacuum system.
- Finger tight assembly (Nut is knurled).
- Easy removal or repositioning in a system.
- HAM LET® "UH" Series is helium leak tested to 4×10^{-9} ATM.cc/sec.
- Maximum Temperature: 242°C.
- "UH" Series is available factory assembled to various HAM-LET® Valves:
 - Ball Valve-Needle Valve-Diaphragm Valve- Filter-Check Valve.
- Materials: All metal parts are 316 Stainless steel, O-Ring - Viton®.
- Full Range of sizes from 1/8 Through 1"

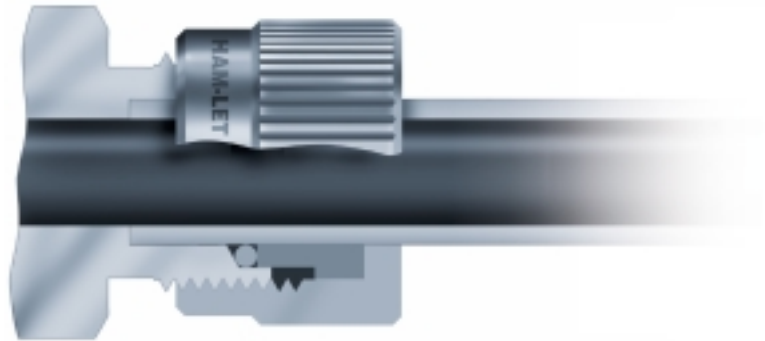

How to Order

768	UH	SS	1/4	X	1/8
Fitting Type	Series Designator	Material Designator SS=316SS B=Brass	Tube O.D		NPT

* Available bored through. Add "R" to the cat. no.

* Parts can be assembled and packed in a cleanroom class 100 if specified.

* Only items priced in HAM-LET's up-to-date price-list are standard.

Price and delivery of non-stock items furnished on request.

768 UH
Male Connector

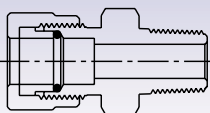

762 UH
Union

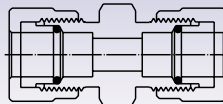

763 UH
Reducing Union

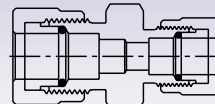

763 LUH
Let-Lok to UH Line

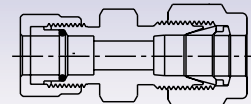

764 UH
Union Tee

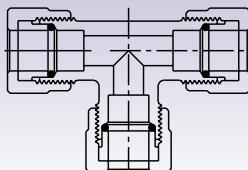

765 UH
Union Elbow

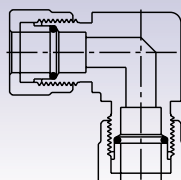

767 UH
UH Line to Pipe Weld

